

OWNER'S MANUAL
Mobile Video System



SAFETY INSTRUCTIONS

Please read this section carefully and follow all the instructions given. This will help ensure reliable operation and extend the service life for your appliance.

- Keep the packaging and the user instructions for future reference or inquiries.
- 1) Never open up the housing of the appliance, it contain no user-serviceable parts. If the housing is opened there is a danger to life from electric shock. Do not place any objects and do not exert any pressure on the appliance.
 - 2) Never allow children to play with electrical equipment unsupervised. Children not always correctly recognize possible danger.
 - 3) If the housing of the appliance become damaged or fluids leak into it. Components must be checked by Customer Service in order to avoid damage!

• Data Security

Every time you update your data make backup copies on an external storage mediums. The supplier does not assume liability for data loss or damage to data storage units, and no claims can be accepted for damages resulting from the loss of data or for consequential damages

• Operating Environment

- 1) Keep your navigation system and all connected devices away from moisture and avoid dust, heat and direct sunlight, especially in the car.
- 2) Make sure you protect your appliance from getting wet. (e.g. from rain and hail, at all times.) Please pay attention that moisture can even build up in a protective pouch because of condensation.
- 3) Avoid heavy vibrations and shaking.
- 4) Failure to follow these instructions may lead to damage to your appliance.

• Ambient Temperature

- 1) The appliance if most reliably operated at an ambient temperature of between 41° F to 104° F (5° C to 40° C) and at a relative humidity of between 10% to 90%.
- 2) In the powered down state the appliance can be stored at between 32° F to 140° F (0° C to 60° C).
- 3) Store the appliance in a safe location to avoid high temperatures (e.g. when parking or from direct sunlight.)

• Electromagnetic Compatibility

When connecting additional or other components the “Electromagnetic Compatibility Directive”(EMC) must be adhered to. Please also note that only screened cable (maximum 10ft) should be used with this appliance. For optimal performance, maintain a distance of at least 10ft. from sources of high-frequency and magnetic interference (televisions, loudspeaker systems, mobile telephones and so on.) This will help avoid malfunctions and loss of data.

• Transport the appliance follow the instructions below:

- 1) Following transport of the appliance wait until the unit has acclimatized before using it. In the case of wide fluctuations in temperature or humidity condensation or moisture may form inside the appliance and this can cause electrical short-circuit. Protect the appliance from dirt, knocks and scratching.
- 2) Before traveling insure that you are aware of the communications provision at your destination.
- 3) When shipping your appliance use only the original packaging and advise the carrier accordingly.
- 4) When taking the product in hand luggage control at airports, it is recommended that you pass the appliance and all magnetic storage media (external hard drives) through the X-ray system. Avoid the magnetic detector (the structure through which you pass) or the magnetic wand (the hand device that the security staff use), since this may corrupt your data.

• Power Through Car Adapter

The car adapter should only be connected to the lighter socket of a car (car battery =DV12V, no trucks!). If you are in any doubt about the power source in your car, contact your car manufacturer.

SAFETY INSTRUCTIONS

- Arrange cables so that no-one can tread on them or trip over them. Do not place any items on the cable.
- **Working with memory card**
This navigation system supports SD memory cards.
- 1) Inserting memory cards:**
Carefully take the memory card out of its packing (if included). Take care not to touch or dirty the contacts. Push the memory card carefully into the card slot. The side of the memory card wearing the label must point upwards. The memory card should slightly lock in place.
- 2) Removing memory cards**
Do not remove the memory card while it is accessed. This could result in loss of data.
To remove the card press lightly onto the upper edge until it ejects.
Pull the card out without touching the contacts.
Store the memory card in the packing or in another safe location. Memory cards are very fragile.
Take care not to dirty the contacts and not to force the card.
- 3) Accessing Memory Cards**
The appliance only supports memory cards in the FAT16/32 file format.
- **Data Exchange VIA Card Reader**
You need a SD card reader to transfer or install map and software data. Insert the card into SD card reader and copy the data directly to the card.
- **Resetting The Navigation System**
This option restarts the navigation system without erasing the data installed. This kind of reset is often used to reorganize the memory. After reset, all running programs are interrupted and the working memory is reinitialized. Choose this option if your navigation system is not responding or working properly.
Press reset button (4) will restart the navigation system.
- **Tips for Navigation**
 - 1) Do not manipulate the navigation system while driving to protect yourself and others from accidents!
 - 2) Only look at the display (not included in the package) when you are in a safe driving situation!
 - 3) Attention: The road layout and driving rules take precedence over the instructions of the navigation system. Only follow the instructions when circumstances and driving rules permit it!
 - 4) The direction statements of the navigation system given do not release the driver of the vehicle from his or her duty of care or personal responsibility.
 - 5) Plan routes before you leave. If you want to play a new route whilst on the road stop driving.
 - 6) In order to receive the GPS signal correctly, metal objects may not hinder reception. Attach the GPS antenna onto the inside of the windscreen or near the windscreen. Try different positions in your vehicle in order to find the best reception
- **Notes for Use In A Vehicle**
Take care that the cable does not impede any safety components. Do not mount the components within the operating range of any airbags. Check all safety equipment in your car after installation.

INSTALLATION

- **Mounting The Navigation Set In A Car**

Use 4 screws ($\phi 5 \times 25$) to install the navigation set to the car, please refer to the followed diagram.

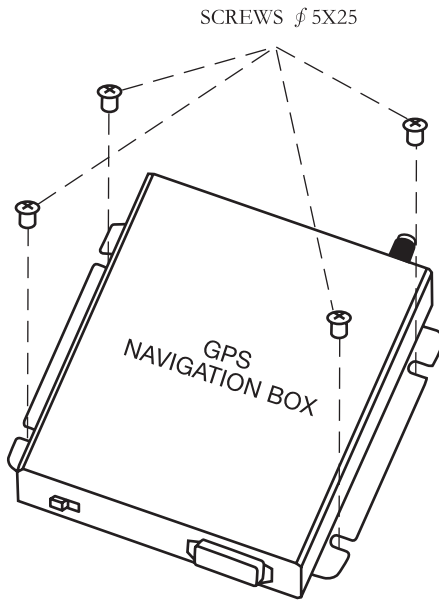

ACCESSORIES

- GPS BOX

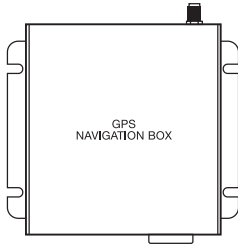

- REMOTE CONTROL

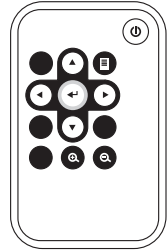

- GPS ANTENNA

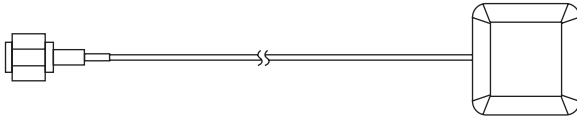

- REMOTE SENSOR

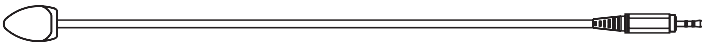

- RGB TO RGB CABLE

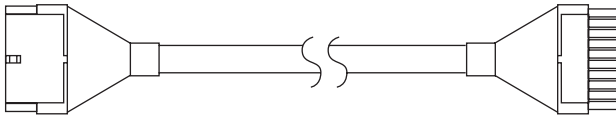

- RGB TO RCA VIDEO LINEOUT

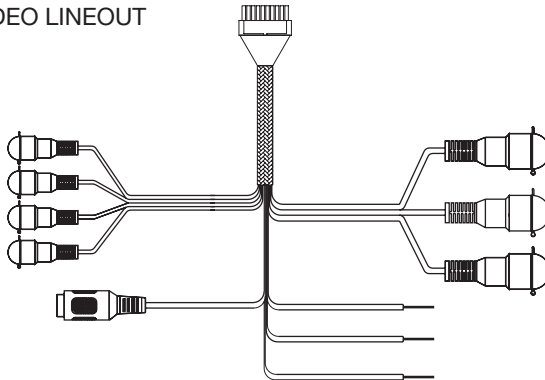

- SD CARD

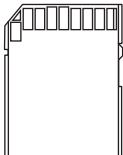

- SCREW ϕ 5X25 (4 PCS)



GPS BOX

One Side

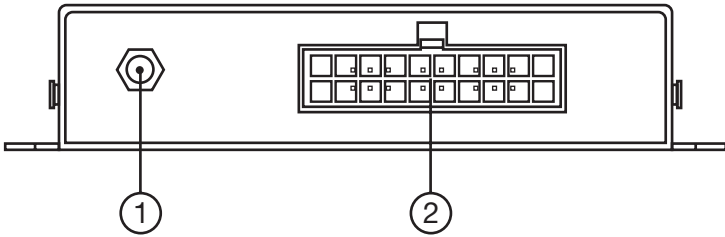

Other Side

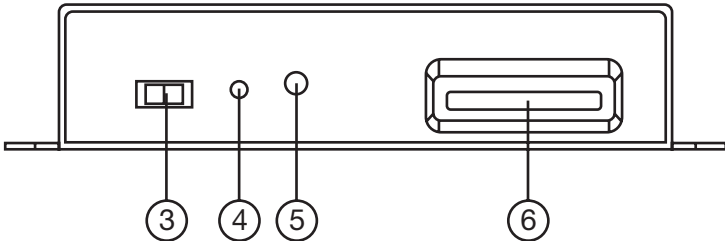

1. GPS ANT (GPS Antenna, To receive GPS signal.)
2. Socket (Connect GPS Box And The Unit)
3. RGB/VIDEO Switch (Switch between RGB mode and VIDEO mode.)
4. RESET (Reset Button)
5. PWR (Power Indicator LED)
6. SD (SD Card Interface)

REMOTE CONTROL

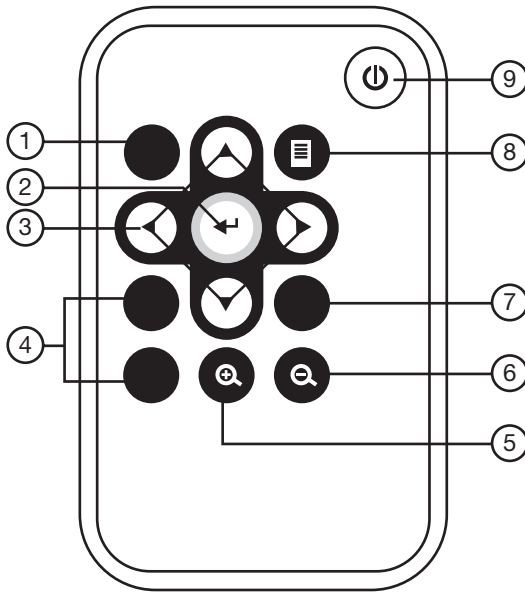

- 1. ESC Press it to exit the current menu.
- 2. ⏩ (ENTER) Press it to enter the selected item.
- 3. ⏪ / ⏩, ▲ / ▼ These buttons serves as navigation-pad, moves up / down / left / right by pushing the corresponding area of the pad.
- 4. VOL+/- Press VOL+/- buttons to increase/decrease the sound.
- 5. 🔍 Zoom out button.
- 6. 🔍 Zoom in button.
- 7. Control Press it to enter control interface.
- 8. ☰ (MENU) Press it to enter the navigation menu.
- 9. ⏻ POWER Press it to turn the GPS box on or off.

ELECTRICAL CONNECTION

Wiring (1)

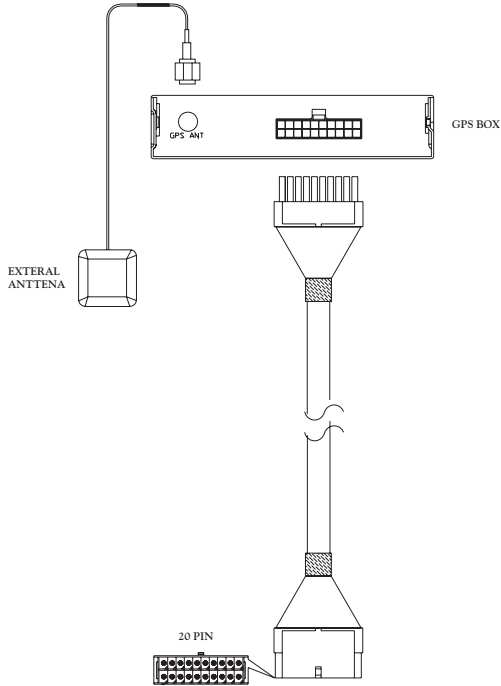

Wiring (2)

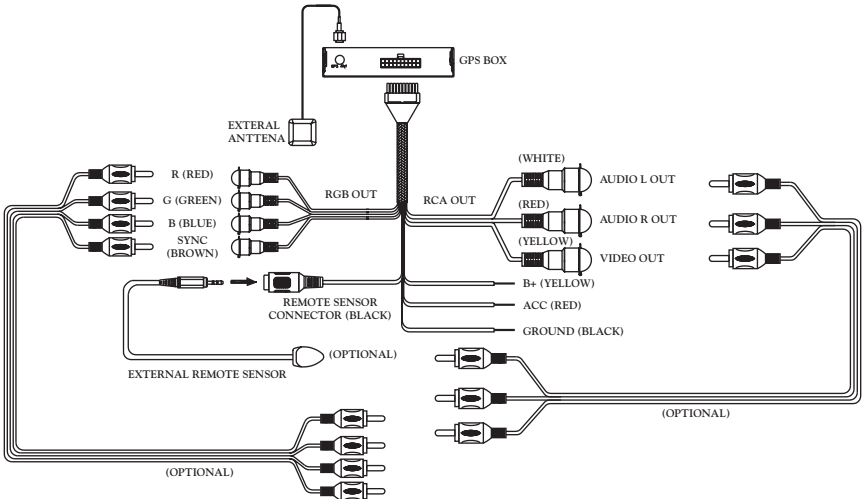

OPERATION

- Console

When all the connections is finished, turn the unit on, switch the mode to navigation mode, the unit will enter the following interface automatically.



Note: If you have set “Auto navigation when power on”, when you turn on the unit, it will skip Console interface and enter navigation interface automatically.

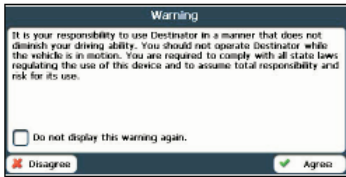

Tap Agree, the following interface will appear, tap Quit will return to Console interface.

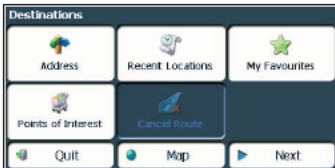

- Setting

Tap icon on Console interface to enter Setting interface like followed:

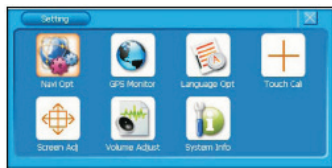

- 1) Use remote control to select icon and enter screen adjust mode, you can see the following interface displayed on screen. Use remote control to move the screen up/down, left/ right. Then press OK button on remote control to

confirm the screen adjustment.

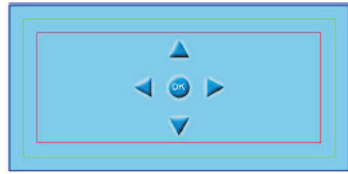

- 2) Tap to enter screen calibration mode, and you can see a plus displayed on screen. Tap the plus firmly, the plus will continue to move until the screen is aligned. And “OK” will appear on screen, tap OK will exit screen calibration mode.

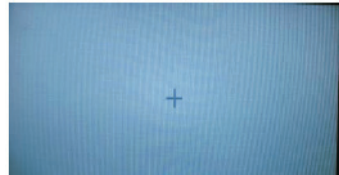

- 3) Tap to enter GPS Monitor interface, it is for factory testing.
- 4) Tap to enter Navi Option interface.

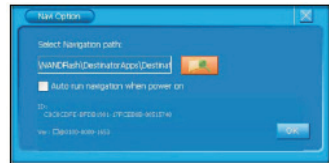

Tap check box Auto run navigation when power on” to enable “Auto run navigation when power on”. When you select “Auto run navigation when power on”, every time when you turn the unit on, it will enter navigation mode automatically.





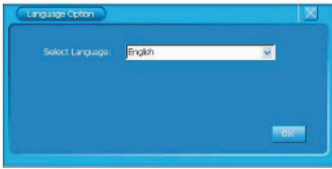

- 5) Tap to enter Language Option menu. You can select system language in this menu.

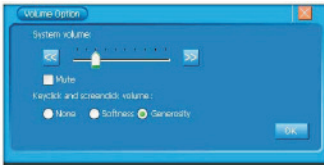
OPERATION



6) Tap  to enter volume option menu.



There are two method to adjust the volume: Method A: When you select  or , press OK button on remote control to adjust the system volume level. Method B: When you select , press  (Left/Right) buttons on remote control to adjust the volume up or down. Tap check box  to mute the sound. Tap  to select keyclick and screenlick volume type among: None, Softness or Generosity. When finishing volume setup, tap  to save and exit current menu.

7) Tap  to enter system info interface. The following information will be displayed in this interface: SN (Serial No.), Hardware Version, Software Version, Total Memory and Available Memory.

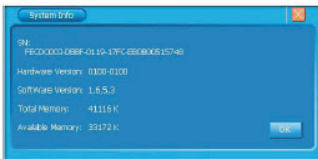

- Navigation
When you connect a GPS box to DVD unit, turn GPS box on then switch the DVD unit mode to navigation mode, you will enter the control interface like followed:



Use the remote control or tap  icon to see following two navigation interface:

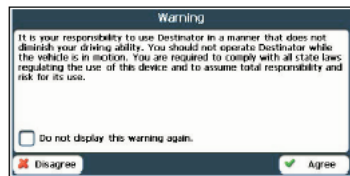

Tap  to enter destinations menu:

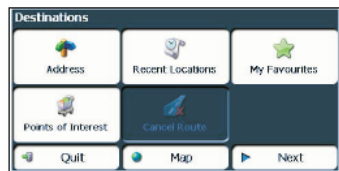

Now you can navigate to anywhere you want just following the instruction on the navigation interface.

How to use the navigation software, please refer to the navigation software instruction manual.

Note: In the video mode, you must select video output signal to the monitor. And In RGB mode, you must select RGB output to the monitor.

SOFTWARE OPERATION

1) When all the connections is finished, turn the unit on, switch the mode to navigation mode, the unit will enter the following interface automatically.



Note: If you have set “Auto navigation when power on”, when you turn on the unit, it will skip Console interface and enter navigation interface automatically.

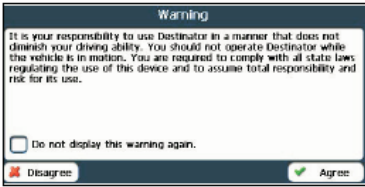

Tap Agree, the following interface will appear, tap Quit will return to Console interface.

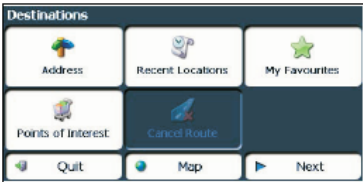

2) Tap icon to enter Setting interface like followed:



3) Tap will enter Navi Option menu:

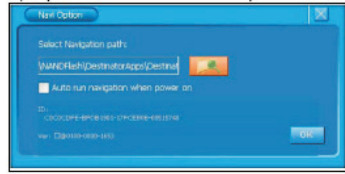

Tap icon to enter Device interface, then select StorageCard folder.

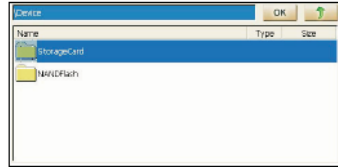

Double tap the StorageCard folder to open it and select Nainstall.exe file.

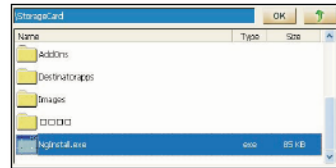

Exit this menu and return to Console interface.

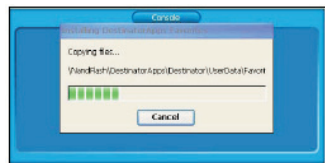

4) Tap icon the navigation software will be installed automatically, and you can see the followed interface:



SOFTWARE OPERATION

When the installation is finished it will return to Console interface automatically.



5) Tap  icon to enter Setting menu, then tap  in Setting menu to enter Navi Option menu:

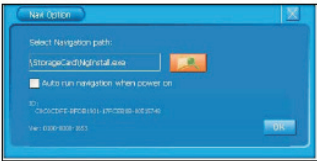

Tap  to enter Device menu:

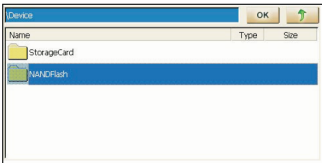

Double tap NANDFlash folder to open it :

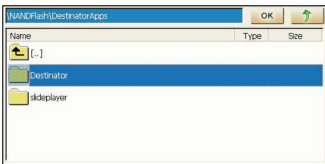

Double tap Destinator folder to enter it and select Dextinator.exe, then tap  to exit current menu.

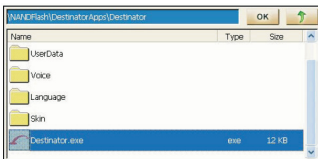

6) Return to Console interface, Tap  icon will enter navigation Interface.

